



一)功能特性

- 1)工作電壓3.0V,超低電源功耗
- 2)時鐘功能,可選擇12/24小時制轉換
- 3)有鬧鐘顯示和貪睡功能
- 4)年曆範圍:2000~2099(開機顯示2004年)
- 4)有3秒LED照明
- 5)溫度測量範圍: -9.9 ~ +70degC(+14.18 ~ 158degF)
- 6)溫度顯示精度:0.1degC
溫度精確度: +/-1degC
- 7)濕度測量範圍:20 ~ 90%RH
濕度顯示精度:1%RH
濕度精確度: +/-5%RH
- 8)開機可以選擇攝氏或華氏單位

二)液晶顯示圖案(含按鍵圖)



六按鍵



五按鍵

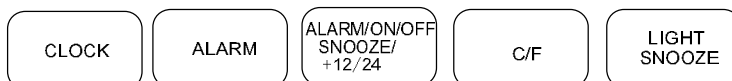

四按鍵





三) 流程圖

六按鍵和五按鍵

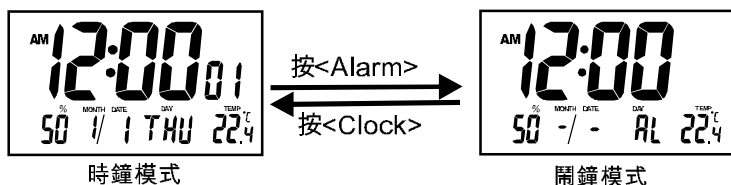

四按鍵

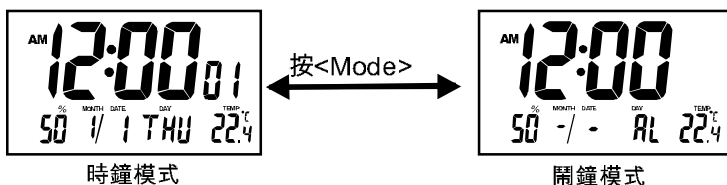

四) 操作說明

1) 設定時間和日期 (六按鍵和五按鍵)

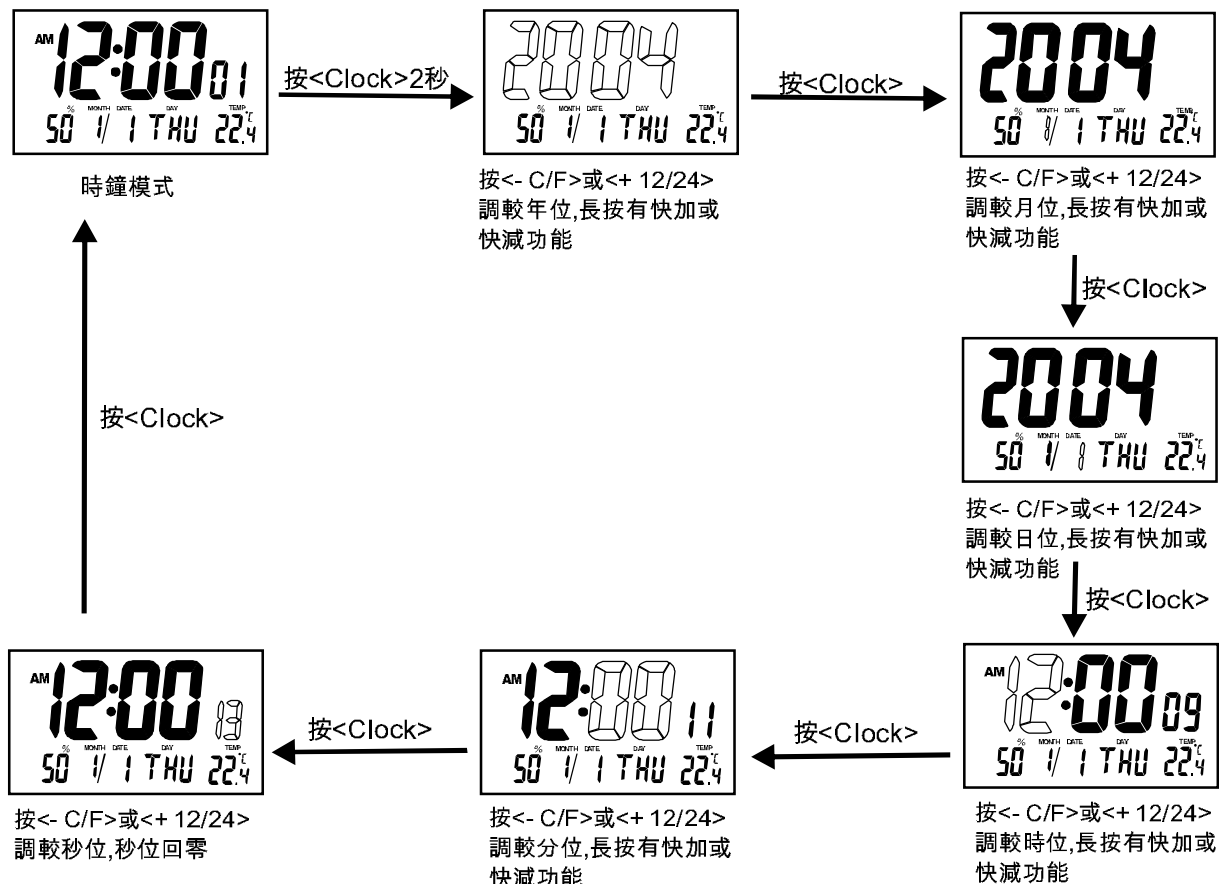

當使用4按鍵時, 按Mode轉換畫面, 按Mode確認



2) 設定鬧鐘

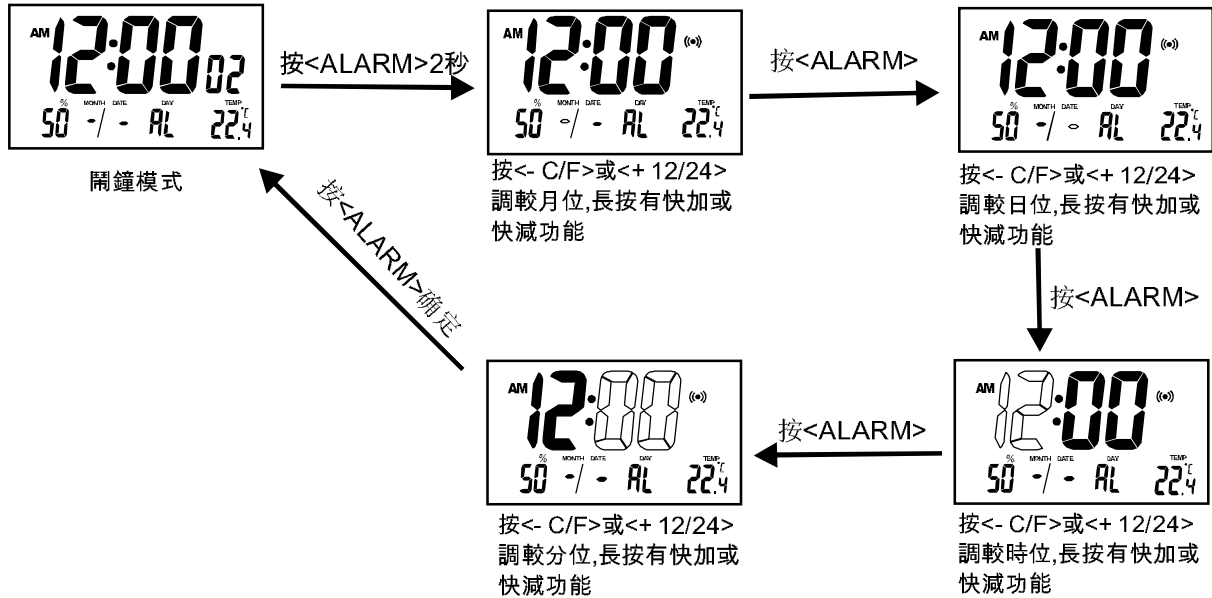

當使用4按鍵時，按Mode轉換畫面，按Mode確認

3) 溫/濕度顯示

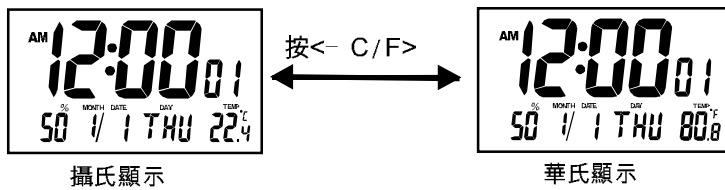



溫濕度時鐘

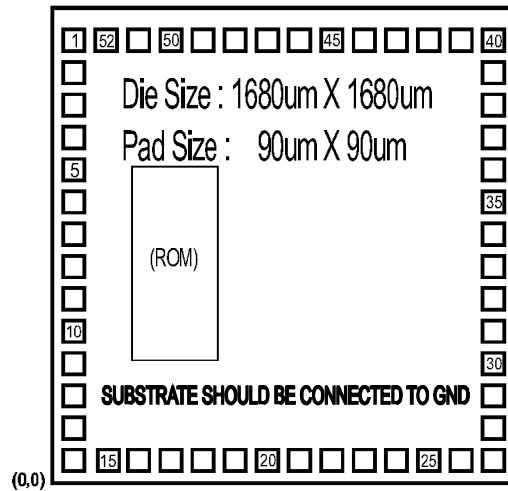

NO	NAME	X	Y	NO	NAME	X	Y
1	BAK	77.5	1602.5	27	SEG13	1602.5	77.5
2	XIN	77.5	1472.5	28	SEG14	1602.5	207.5
3	XOUT	77.5	1357.5	29	SEG15	1602.5	322.5
4	GND	77.5	1242.5	30	SEG16	1602.5	437.5
5	VDD1	77.5	1127.5	31	SEG17	1602.5	552.5
6	VDD2	77.5	1012.5	32	SEG18	1602.5	667.5
7	VDD3	77.5	897.5	33	SEG19	1602.5	782.5
8	CUP1	77.5	782.5	34	SEG20	1602.5	897.5
9	CUP2	77.5	667.5	35	SEG21	1602.5	1012.5
10	COM1	77.5	552.5	36	SEG22	1602.5	1127.5
11	COM2	77.5	437.5	37	SEG23	1602.5	1242.5
12	COM3	77.5	322.5	38	CX	1602.5	1357.5
13	COM4	77.5	207.5	39	RR	1602.5	1472.5
14	COM5	77.5	77.5	40	RT	1602.5	1602.5
15	SEG1	207.5	77.5	41	RH	1472.5	1602.5
16	SEG2	322.5	77.5	42	SEG28	1357.5	1602.5
17	SEG3	437.5	77.5	43	SEG29	1242.5	1602.5
18	SEG4	552.5	77.5	44	SEG30	1127.5	1602.5
19	SEG5	667.5	77.5	45	BZ	1012.5	1602.5
20	SEG6	782.5	77.5	46	K11	897.5	1602.5
21	SEG7	897.5	77.5	47	K12	782.5	1602.5
22	SEG8	1012.5	77.5	48	K13	667.5	1602.5
23	SEG9	1127.5	77.5	49	K14	552.5	1602.5
24	SEG10	1242.5	77.5	50	RESET	437.5	1602.5
25	SEG11	1357.5	77.5	51	LIGHT	322.5	1602.5
26	SEG12	1472.5	77.5	52	N.C.	207.5	1602.5

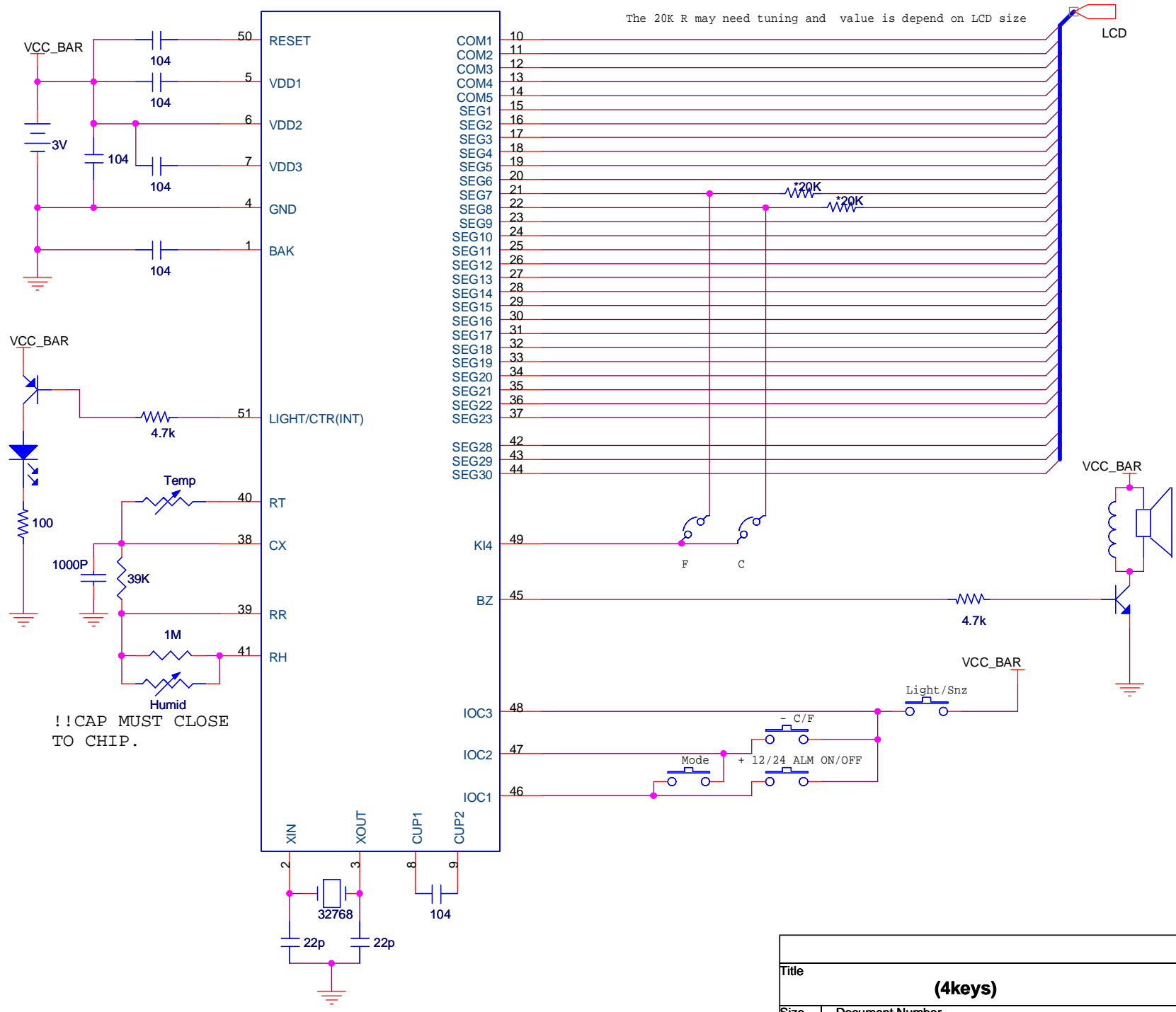

Title		
(4keys)		
Size	Document Number	Rev
		1.2

The 20K R may need tuning and value is depend on LCD size

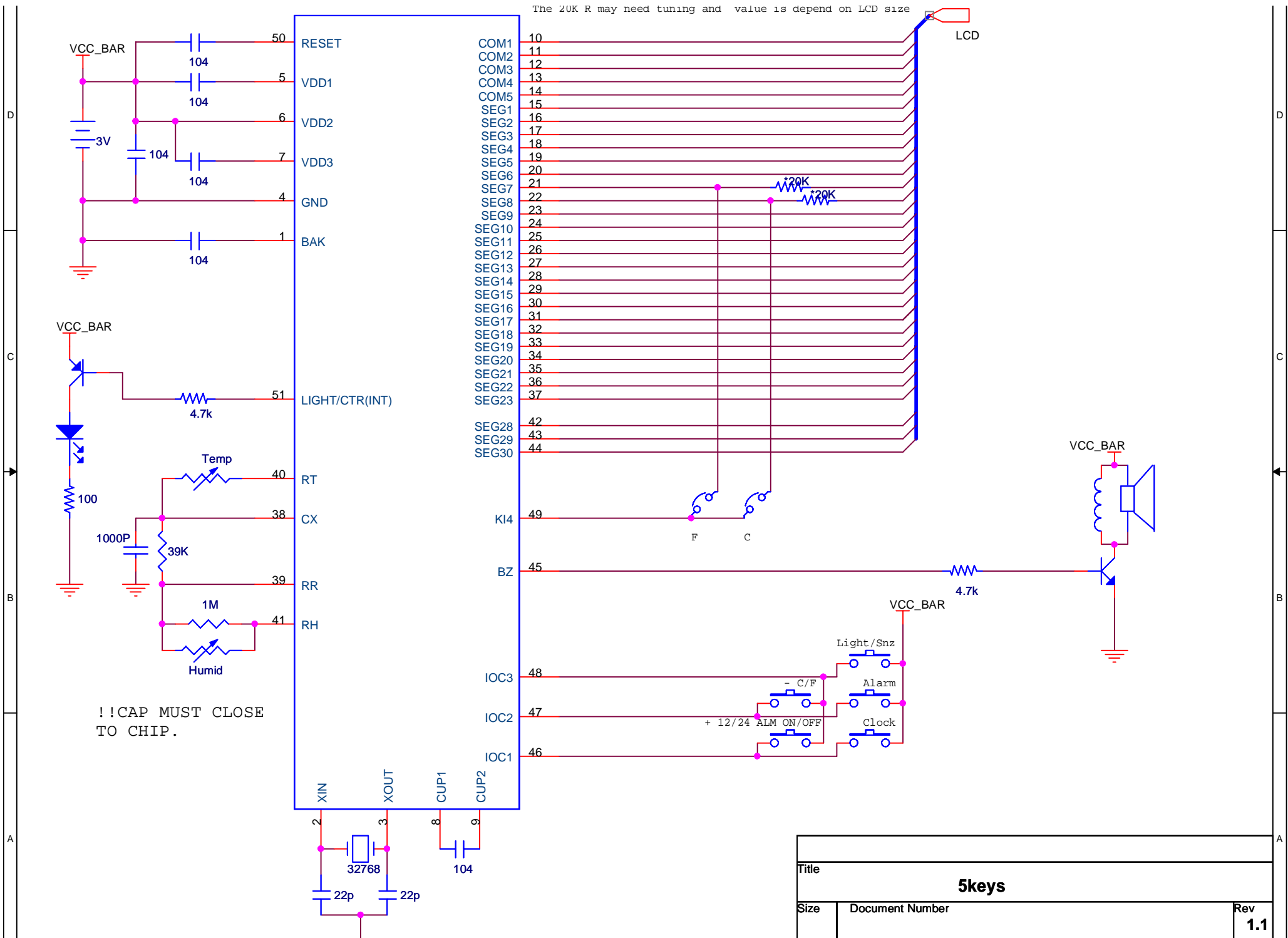

Title		
5keys		
Size	Document Number	Rev
		1.1

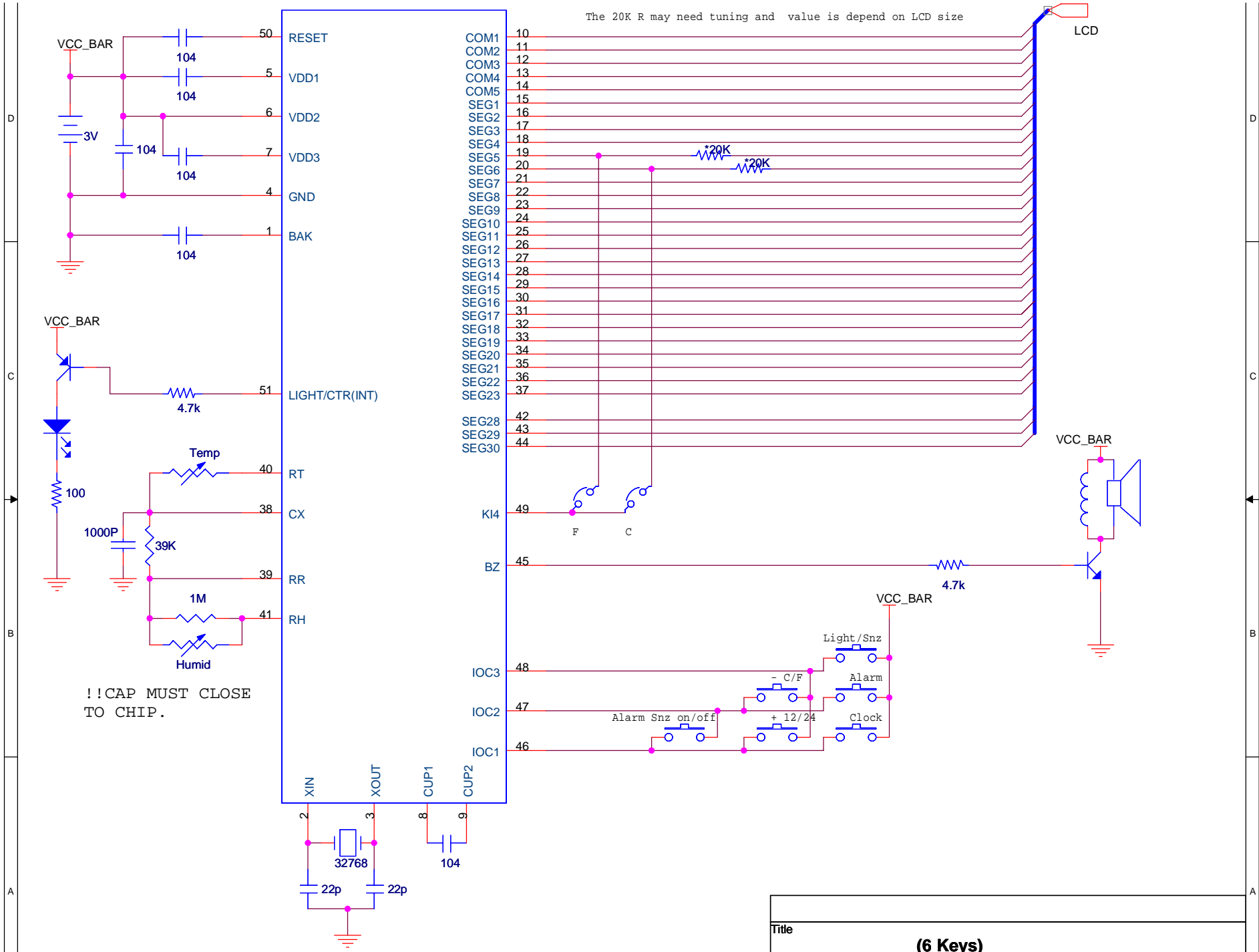

!!CAP MUST CLOSE TO CHIP.

Title		
(6 Keys)		
Size	Document Number	Rev
		1.2



深圳市晶峰达电子科技有限公司
东莞市琪芯电子有限公司

电话: 13798528768, 0755-29206918, FAX: 81703081
邮箱: info@jfd-ic.com, QQ: 402431824 阿里旺旺: szjfdz
网址: www.jfd-ic.com MSN: aleafuyzf@hotmail.com

DL8062

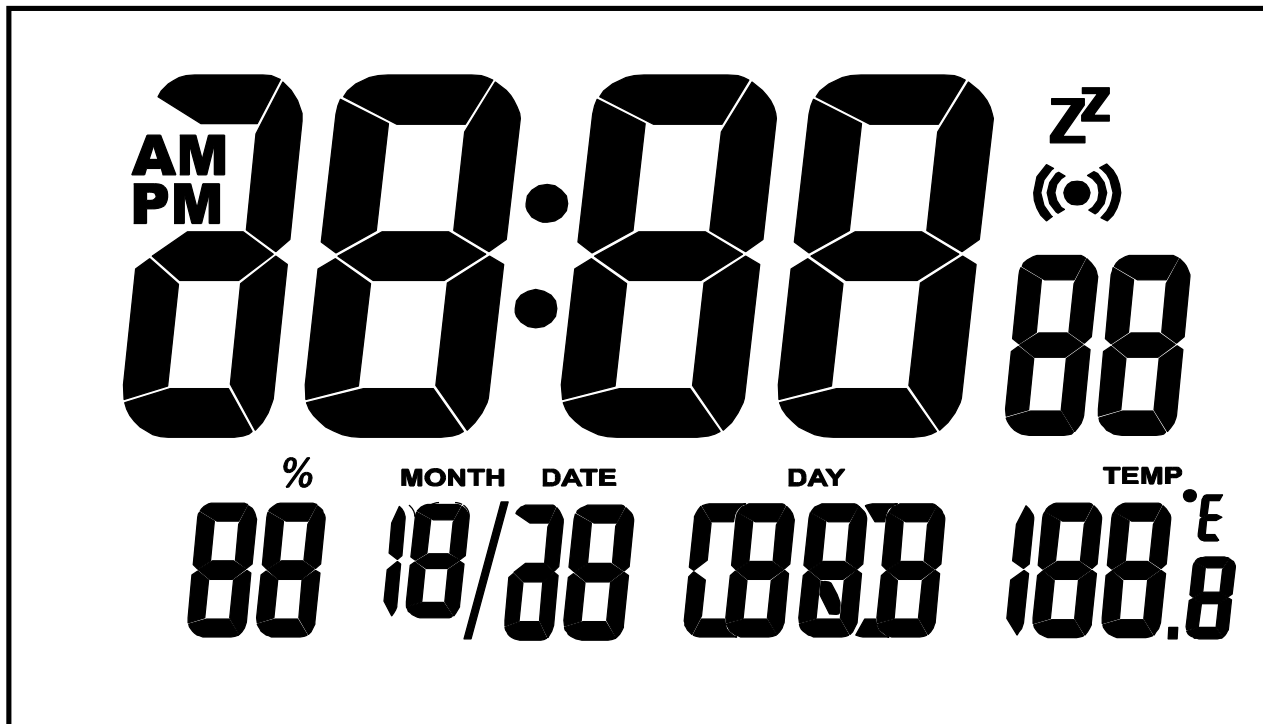

1/5 Duty, 1/3 Bias, Vlcd=4.5V



深圳市晶峰达电子科技有限公司

东莞市琪芯电子有限公司

电话: 13798528768, 0755-29206918, FAX: 81703081
邮箱: info@jfd-ic.com, QQ: 402431824 阿里旺旺: szjfdz
网址: www.jfd-ic.com MSN: aleafuyzf@hotmail.com

DL8062

