



深圳市晶峰达电子科技有限公司
ShenZhen JinFengDa Electronic Technology Co., Ltd.
地址:深圳市龙岗街道 电话:0755-29206918, 13798528768
网站:www.jfd-ic.com 邮箱:info@jfd-ic.com QQ:402431824

DL6015 带中文年月日星期温湿度时钟 IC

产 品 说 明 书

一) 功能特性

- 1) 工作電壓1.5V, 超低電源功耗
- 2) 基本的時間顯示, 有12/24小時轉換
- 3) 年曆範圍: 1940~2099年. (開機顯示2001年)
- 4) 日期顯示 (月、日、星期)
- 5) 星期自動調整
- 6) 溫度範圍: $-9 \sim +70 \text{ degC}$ ($-15.8 \sim +158 \text{ degF}$)
溫度精確度: $\pm 1 \text{ deg}$.
溫度顯示精度: 0.1 degC
- 7) 邦定選擇:
 - 三按鍵或四按鍵
 - 日期、時間轉換顯示或固定顯示
 - 攝氏或華氏顯示溫度

二) 液晶顯示圖案

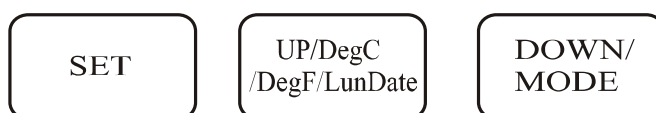
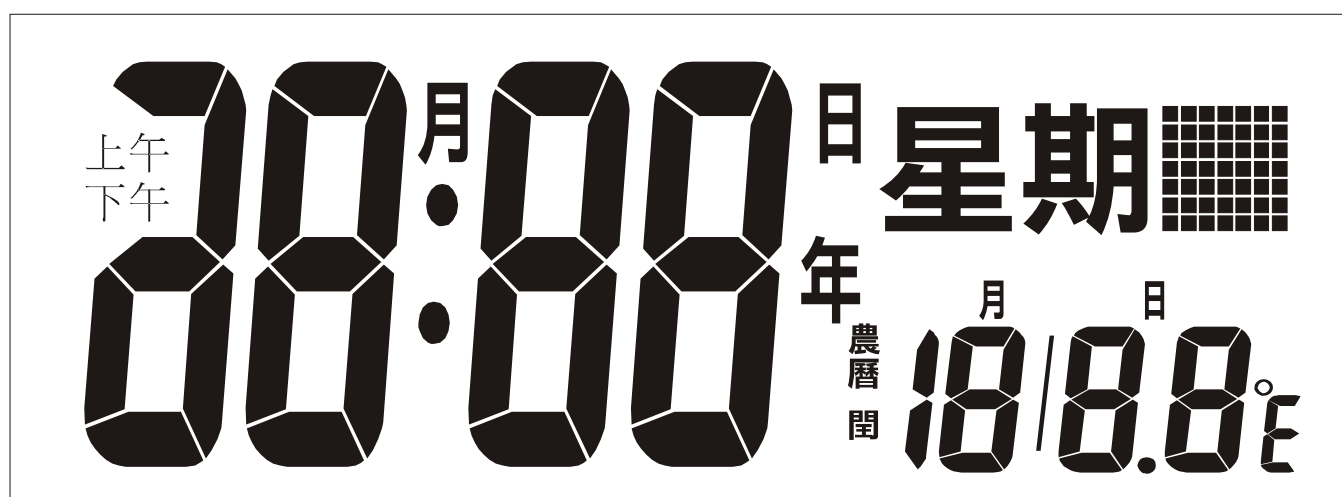

三按鍵



四按鍵

三) 流程圖

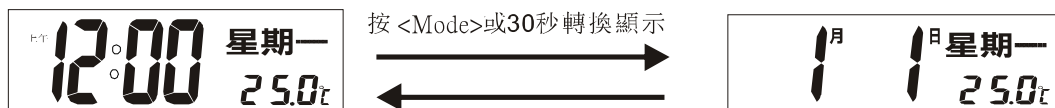

四) 選擇攝氏或華氏顯示溫度

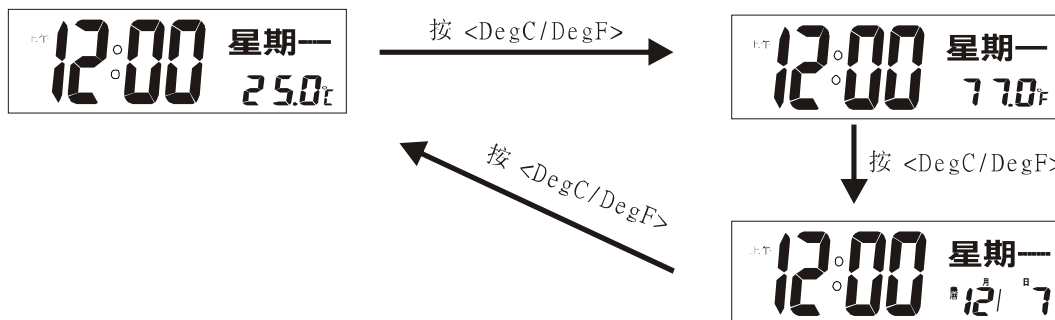

五) 設定日期時間

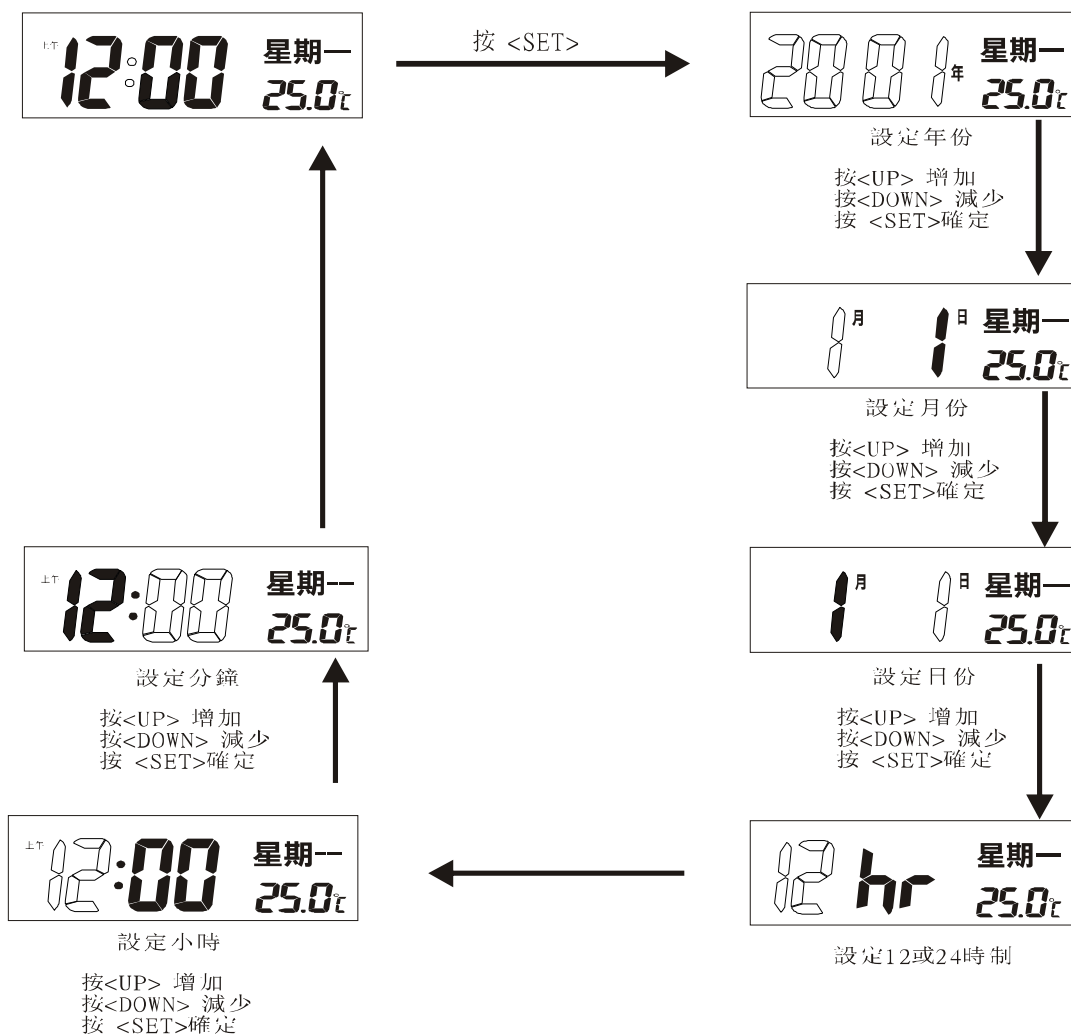

DL6015V

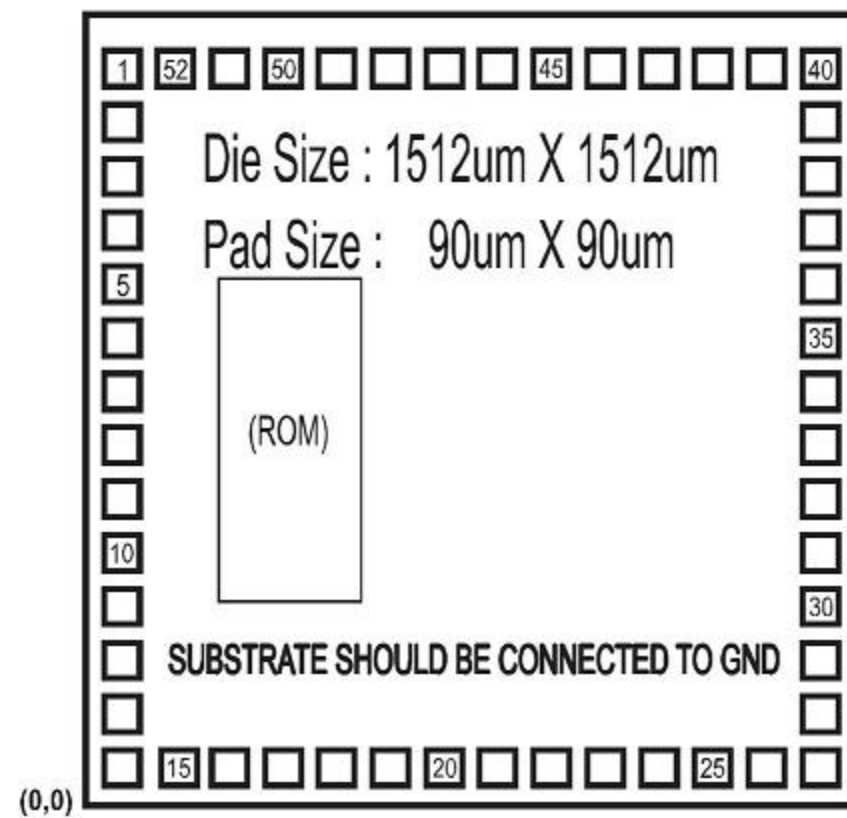

NO	NAME	X	Y	NO	NAME	X	Y
1	BAK	69.75	1422.25	27	SEG13	1442.25	69.75
2	XIN	69.75	1325.25	28	SEG14	1442.25	186.75
3	XOUT	69.75	1221.75	29	SEG15	1442.25	290.25
4	GND	69.75	1118.25	30	SEG16	1442.25	393.75
5	VDD1	69.75	1014.75	31	SEG17	1442.25	497.25
6	VDD2	69.75	911.25	32	N.C.	1442.25	600.75
7	VDD3	69.75	807.75	33	N.C.	1442.25	704.25
8	CUP1	69.75	704.25	34	N.C.	1442.25	807.75
9	CUP2	69.75	600.79	35	N.C.	1442.30	911.29
10	COM1	69.75	497.25	36	SEG22	1442.25	1014.75
11	COM2	69.75	393.75	37	SEG23	1442.25	1118.25
12	COM3	69.75	290.25	38	SEG24	1442.25	1221.75
13	COM4	69.75	186.75	39	IOA2	1442.25	1325.25
14	COM5	69.75	69.75	40	IOA3	1442.25	1442.25
15	SEG1	186.75	69.75	41	SEG27	1325.25	1442.25
16	SEG2	290.25	69.75	42	SEG28	1221.75	1442.20
17	SEG3	393.75	69.75	43	SEG29	1118.25	1442.25
18	SEG4	497.25	69.75	44	SEG30	1014.75	1442.25
19	SEG5	600.75	69.75	45	SEG31	912.42	1441.89
20	SEG6	704.25	69.75	46	SEG32	807.75	1442.25
21	SEG7	807.75	69.75	47	KI2	704.25	1442.25
22	SEG8	911.25	69.75	48	IOC3	600.75	1442.25
23	SEG9	1014.75	69.75	49	IOC4	497.25	1442.25
24	SEG10	1118.25	69.75	50	RESET	393.75	1442.25
25	SEG11	1221.75	69.75	51	INT	290.25	1442.25
26	SEG12	1325.25	69.75	52	N.C.	186.75	1442.25

DL6015 LCD

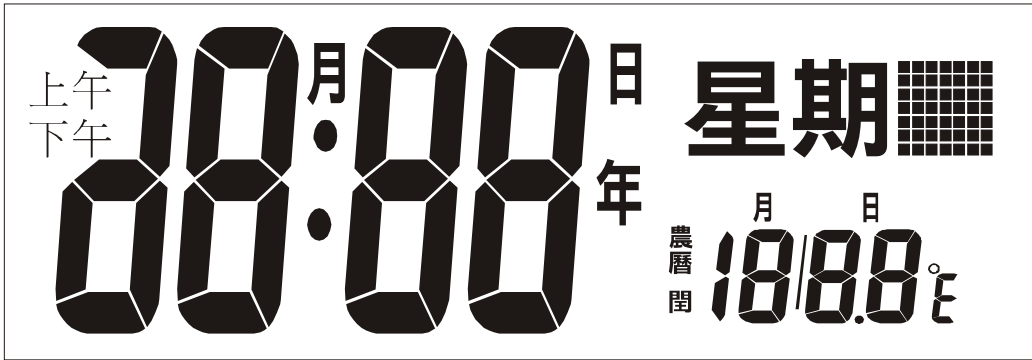

1/5 DUTY, 1/3 BIAS, Vlcd=4.5 volt

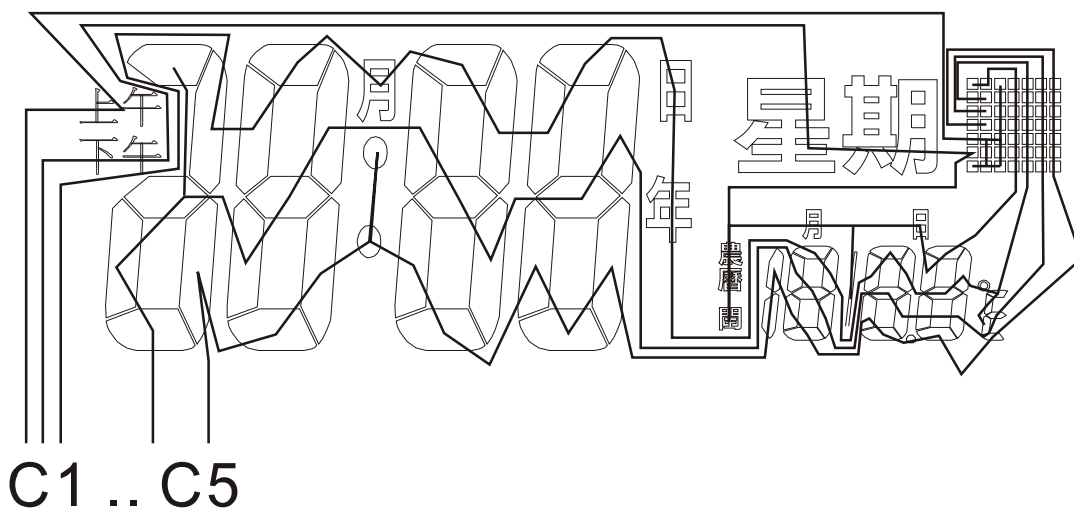
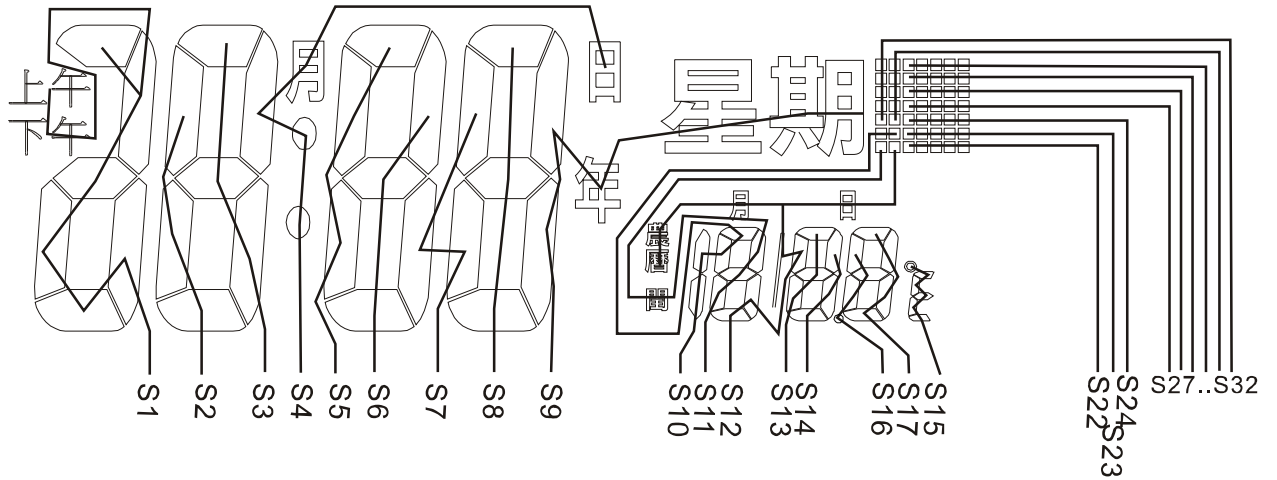

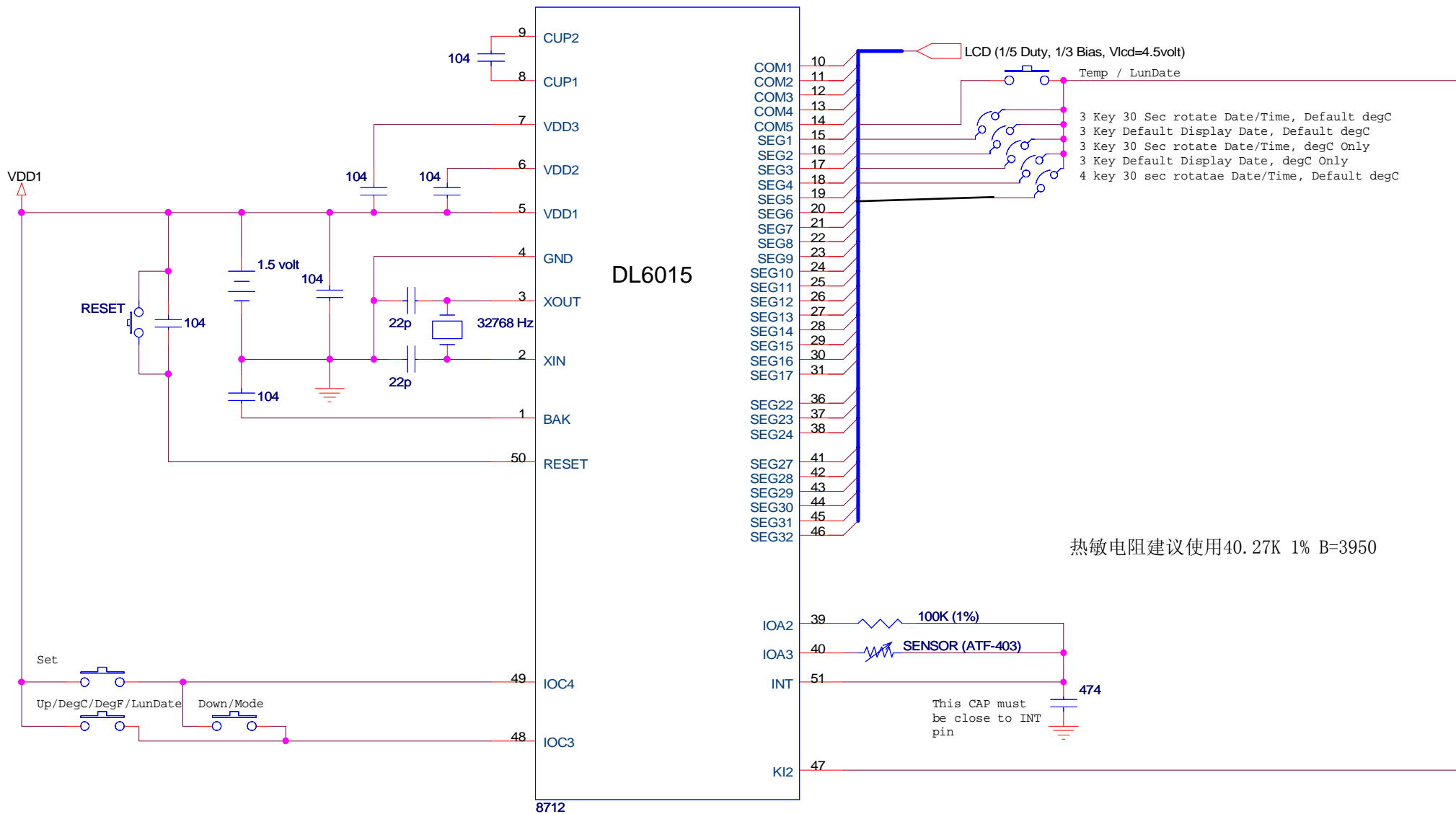

热敏电阻建议使用40.27K 1% B=3950

Title		
DL6015		
Size	Document Number	Rev
Custom		1.
Date:	Thursday, June 26, 2008	Sheet 1 of 1
	2	1