

DL1227

一)功能特性

- 1) 工作電壓3.0V,超低電源功耗
- 2) 基本的時間顯示,有12/24小時轉換
- 3) 年曆範圍:2000~2099年 (開機顯示2004年)
- 4) 可選擇攝氏或華氏顯示溫度
- 5) 溫度範圍:-50~+70degC
溫度精確度:+/-1degC
溫度顯示精度:0.1degC
- 6) 有鬧鐘顯示和5分鐘貪睡功能
- 7) 有倒計時功能 (最大倒計時為23:59:59)
- 8) 有按鍵提示音
- 9) 有3秒燈光照明
- 10) 邦定或自行選擇星期顯示: 英,法,德,意,西

二)液晶顯示圖案

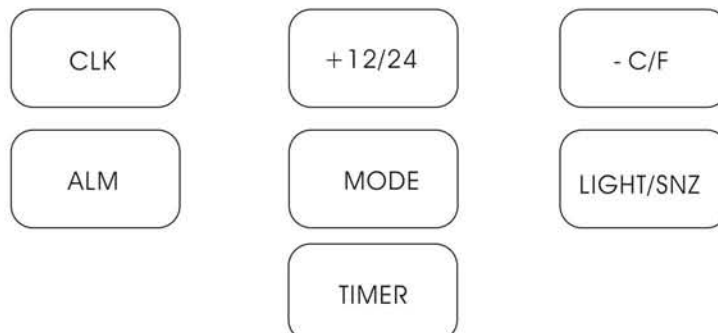
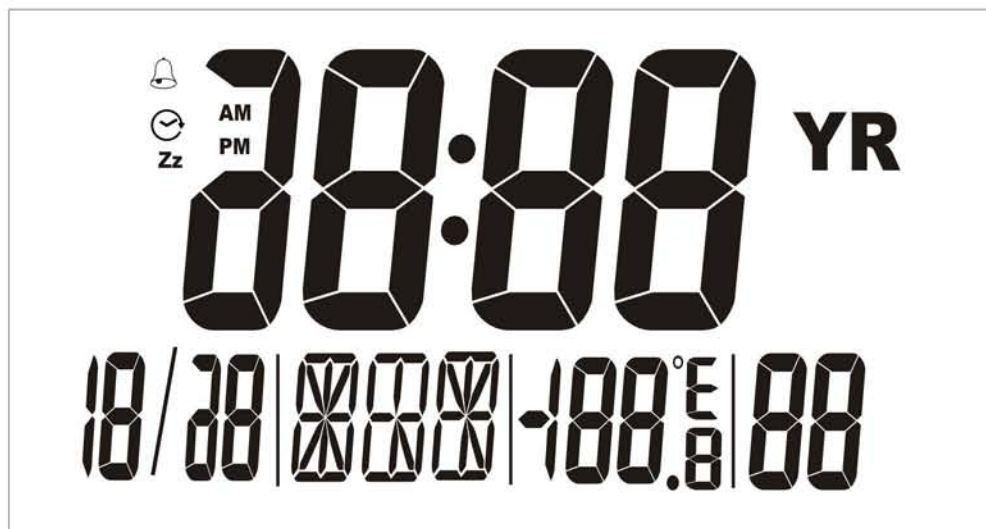

DL1227

三) 流程圖



四) 操作說明

1) 設定時間和日期

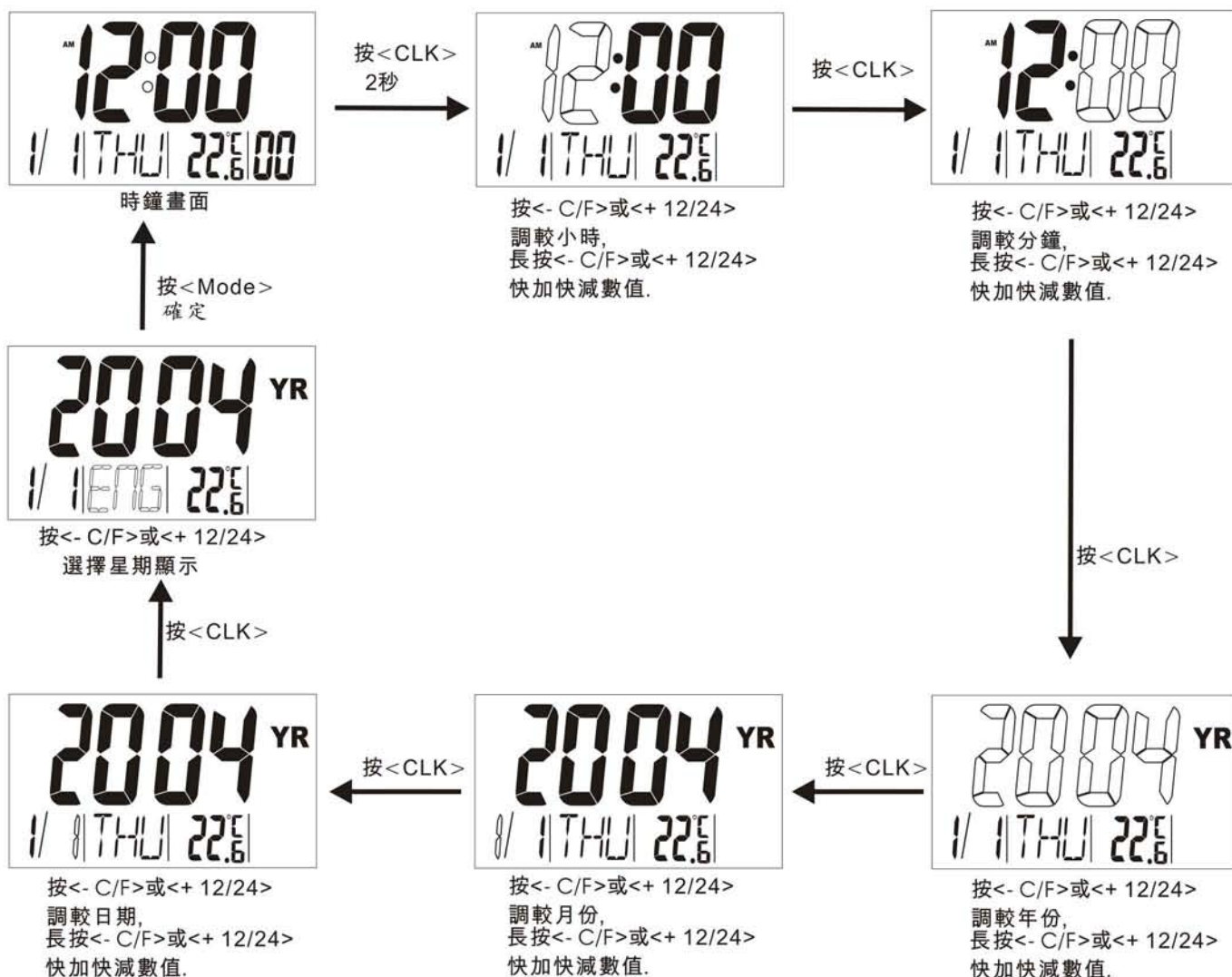

DL1227

2) 設定鬧鐘

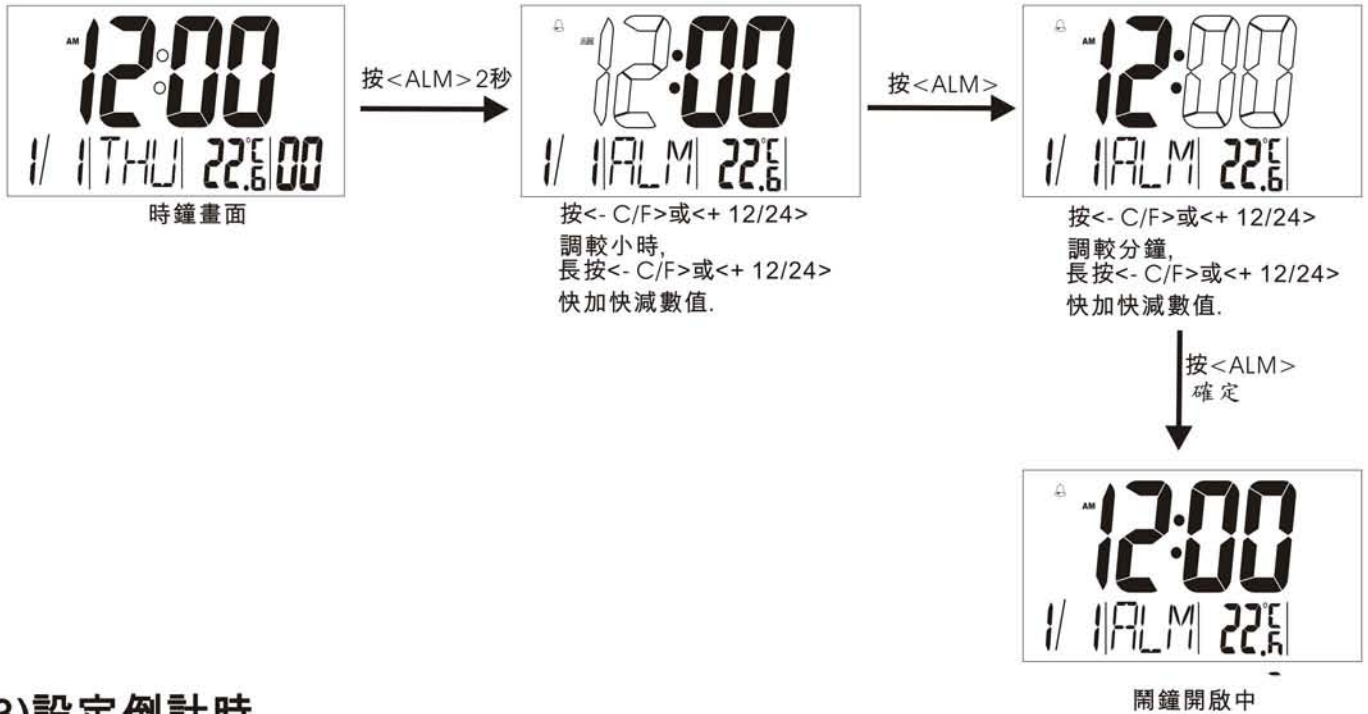

3) 設定倒計時

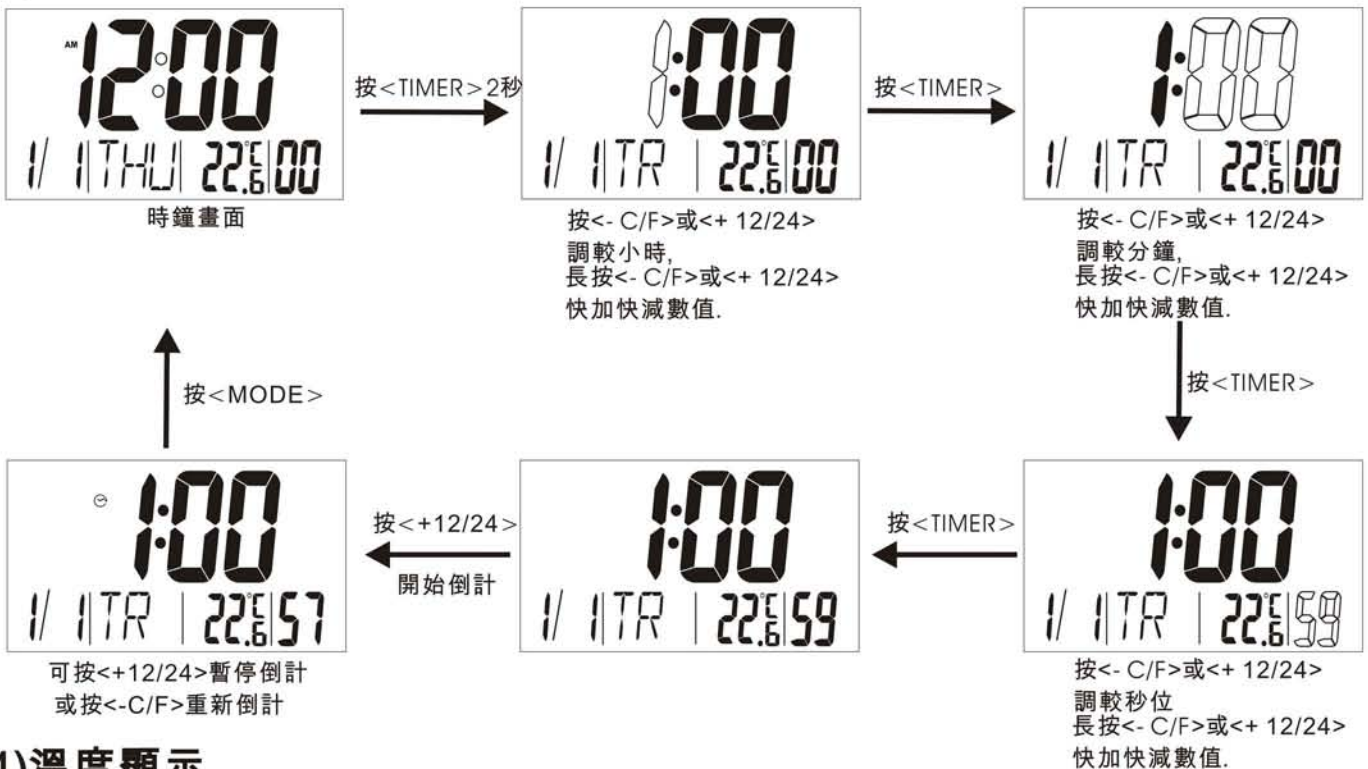

4) 溫度顯示

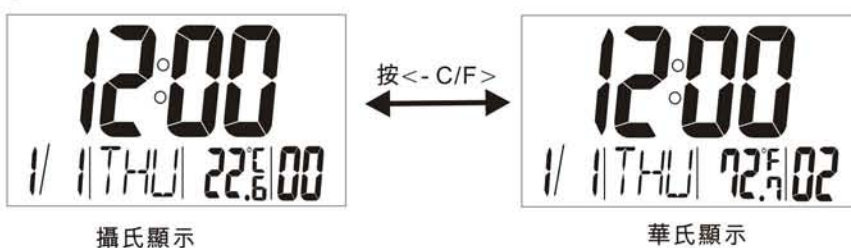

DL1227

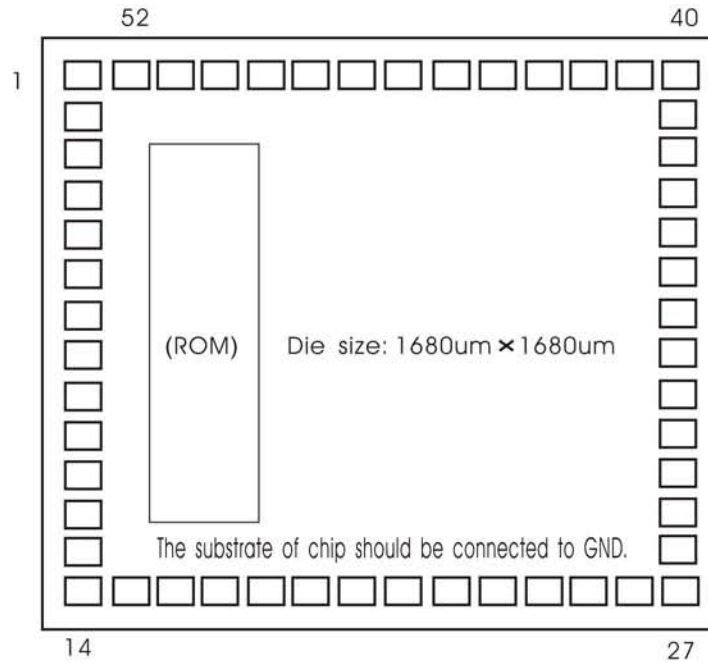

NO	NAME	X	Y	NO	NAME	X	Y
1	BAK	77.5	1602.5	27	SEG13	1602.5	77.5
2	XIN	77.5	1472.5	28	SEG14	1602.5	207.5
3	XOUT	77.5	1357.5	29	SEG15	1602.5	322.5
4	GND	77.5	1242.5	30	SEG16	1602.5	437.5
5	VDD1	77.5	1127.5	31	SEG17	1602.5	552.5
6	VDD2	77.5	1012.5	32	SEG18	1602.5	667.5
7	VDD3	77.5	897.5	33	SEG19	1602.5	782.5
8	CUP1	77.5	782.5	34	SEG20	1602.5	897.5
9	CUP2	77.5	667.5	35	SEG21	1602.5	1012.5
10	COM1	77.5	552.5	36	SEG22	1602.5	1127.5
11	COM2	77.5	437.5	37	SEG23	1602.5	1242.5
12	COM3	77.5	322.5	38	IOA1	1602.5	1357.5
13	COM4	77.5	207.5	39	IOA2	1602.5	1472.5
14	COM5	77.5	77.5	40	IOA3	1602.5	1602.5
15	SEG1	207.5	77.5	41	SEG24	1472.5	1602.5
16	SEG2	322.5	77.5	42	SEG25	1372.5	1602.5
17	SEG3	437.5	77.5	43	OPT	1242.5	1602.5
18	SEG4	552.5	77.5	44	LIGHT	1127.5	1602.5
19	SEG5	667.5	77.5	45	BZ	1012.5	1602.5
20	SEG6	782.5	77.5	46	IOC1	897.5	1602.5
21	SEG7	897.5	77.5	47	IOC2	782.5	1602.5
22	SEG8	1012.5	77.5	48	IOC3	667.5	1602.5
23	SEG9	1127.5	77.5	49	IOC4	552.5	1602.5
24	SEG10	1242.5	77.5	50	RESET	437.5	1602.5
25	SEG11	1357.5	77.5	51	INT	322.5	1602.5
26	SEG12	1472.5	77.5	52	N.C.	207.5	1602.5

DL1227

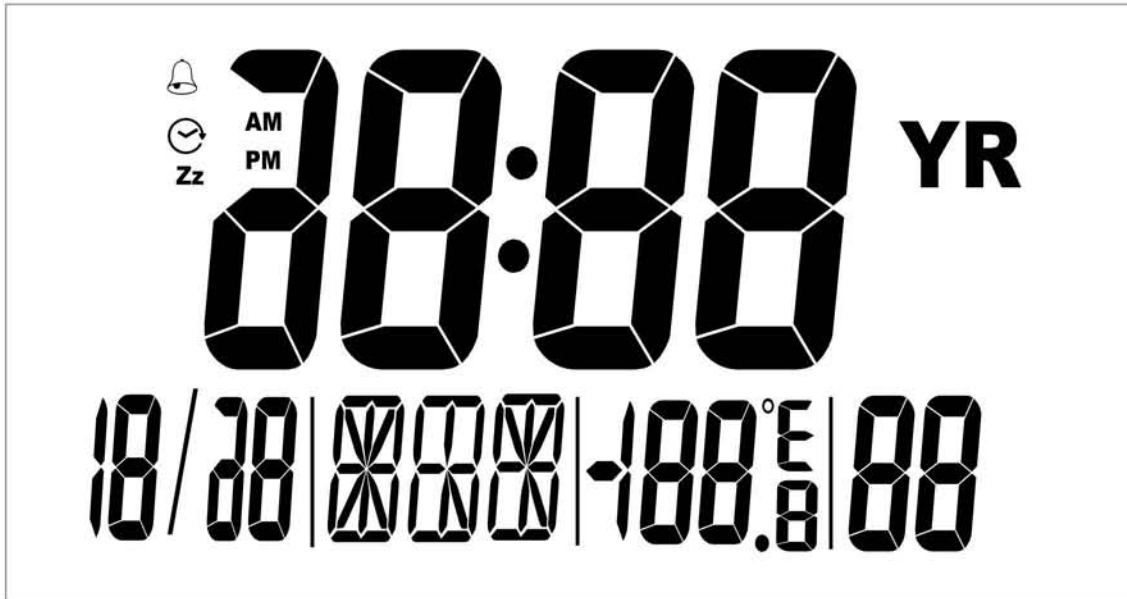

1/5 Duty, 1/3 Bias, Vlcd 4.5V

DL1227

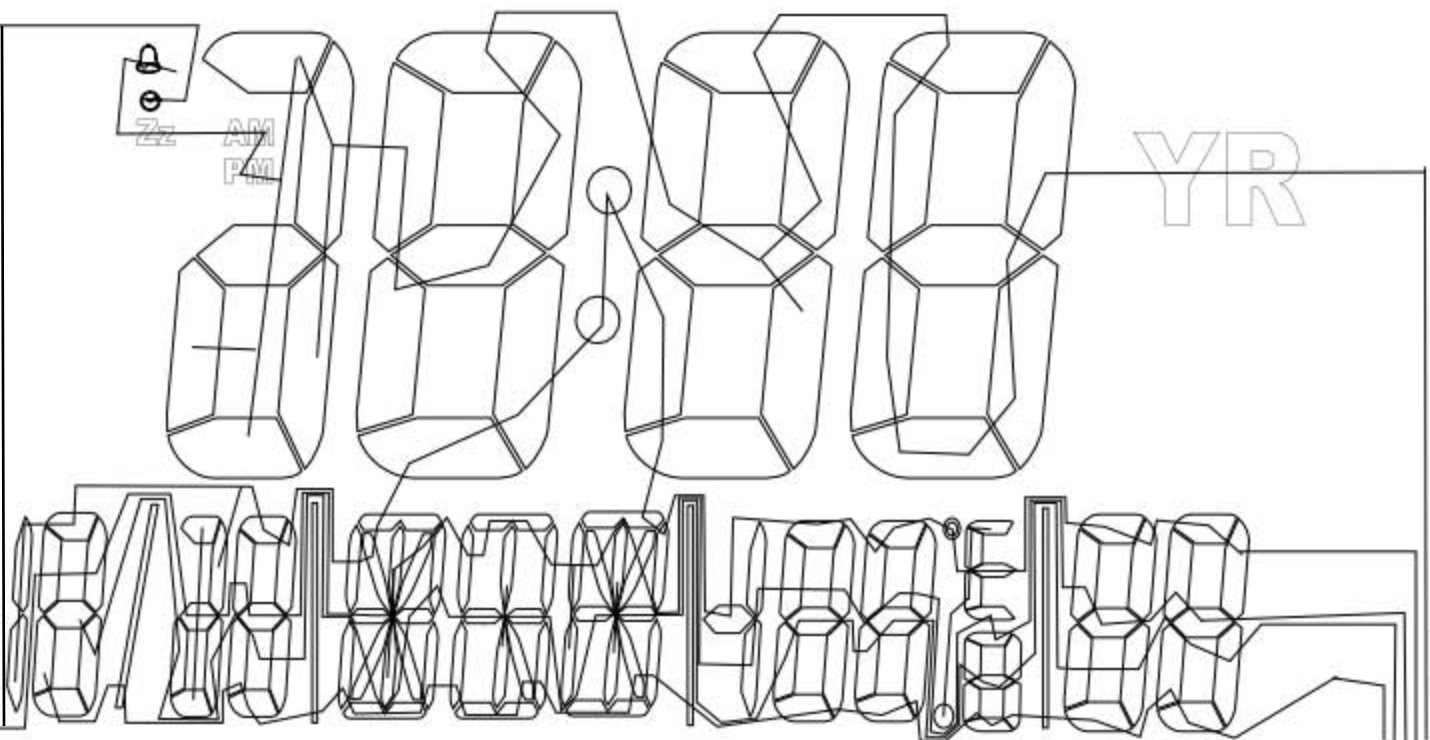
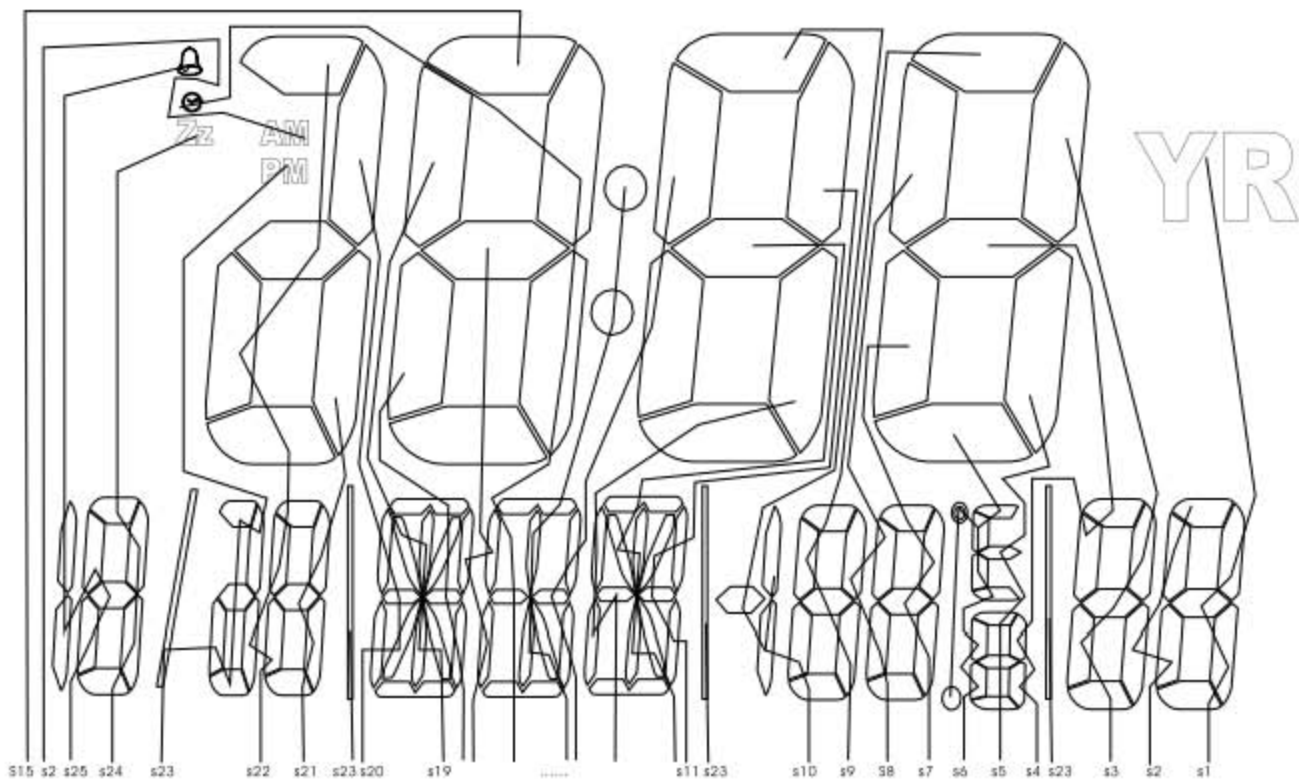

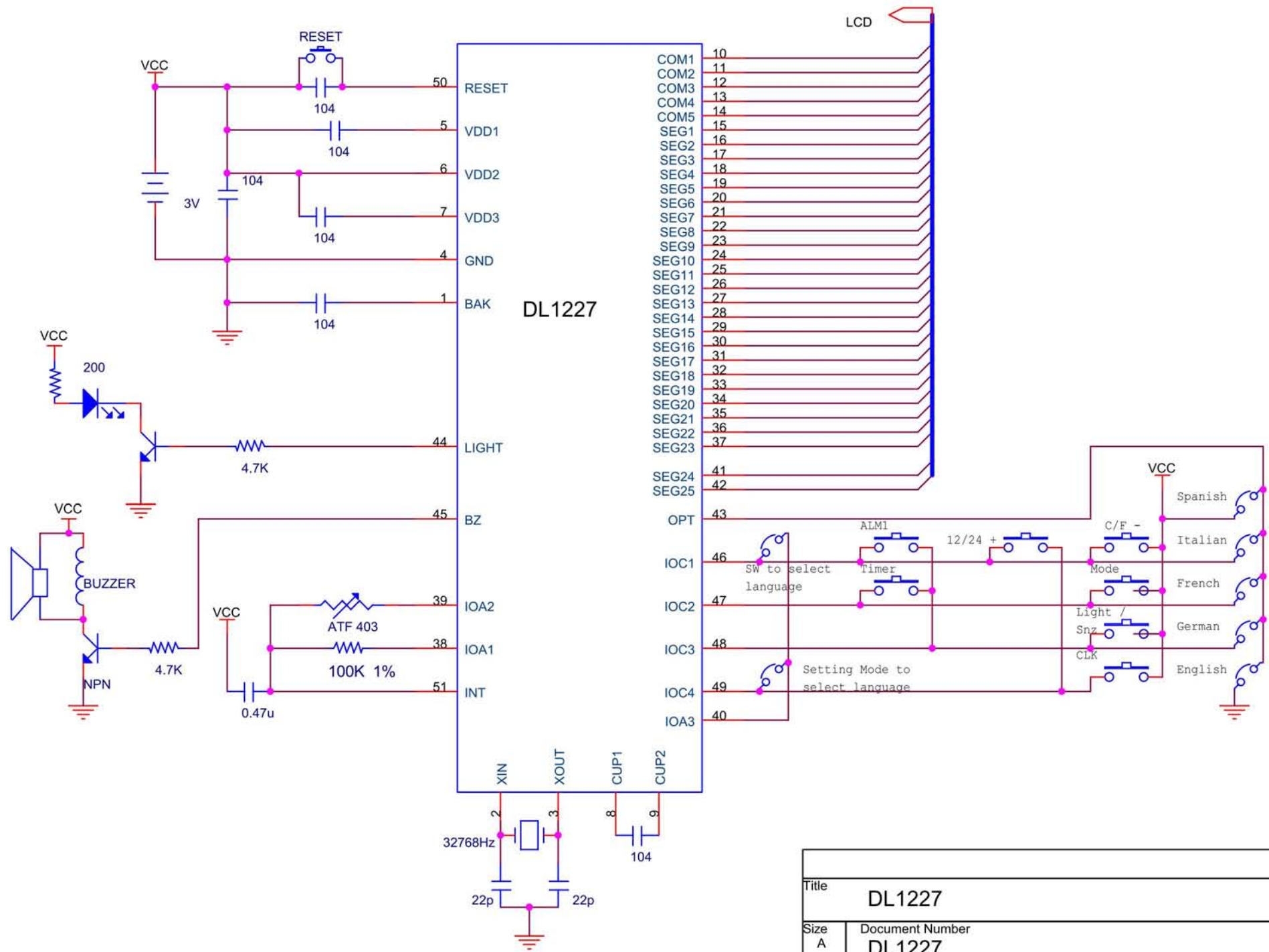

Title		
DL1227		
Size	Document Number	Rev
A	DL1227	1.1
Date:	Sheet 1 of 1	