

3.5-Digit LCD Clock with Alarm and Snooze

C1937A

GENERAL DESCRIPTION

C1937A is a CMOS integrated circuit which is 2-function clock with alarm and snooze function and can drive a 3.5-digit duplexed liquid crystal display with Colon, PM-Time and Snooze, Alarm, Alarm standby icons. This chip provides an variable alarm sound with crescendo.

FUNCTIONS

- 3.5 digit LCD 2 function clock: Hour and Minute
- Alarm tone 4 step variable with crescendo
- 60-second alarm autostop
- Snooze function
- Drives 3.5-digit duplexed LCD with five icons: Colon, PM, Alarm, Alarm standby, Snooze
- Direct drive of piezoelectric transducer
- Alarm enable / disable
- Colon display flash or freeze available

FEATURES

- Single 1.5V battery operation
- Single-chip CMOS construction
- 32768 Hz quartz crystal time base
- Alarm Sound Demonstration Capability
- 7 operational switches (with pull-down resistor)
- Built-in chip oscillator, capacitor, resistor and voltage doubler.

PIN DESCRIPTION

Function	Name	Number	Description
Power Supply Voltage Doubler	VDD, VSS	2	Positive & negative supply
	VDD2	3	VDD2=3V for driving LCD
	VCP, VCM		Voltage doubler capacitor positive & negative
Alarm Output LCD Drive Output	BD, BD bar	2	Directly drive Piezo
	COL/PM, D2/BC1, E2/F2, G2/A2 C2/B2, E3/F3, G3/AD3, C3/B3 E4/F4, G4/A4, C4/B4, SNZ/ALM D4/AS	13	LCD segments
Oscillator	COM1, COM2	2	LCD Backplanes
	OSCI, OSCO	3	Oscillator input & output
	OSCI-C		Oscillator input with built-in Capacitor
Switch	NORS	1	Normal time mode set
	ALS	1	Alarm time mode set
	SNZ	1	Snooze operation
	ALOFF	1	Alarm off
	HR	1	Hour digit set
	MIN	1	Minute digit set
	ALSTOP	1	Alarm stop pin
	TRIG	1	Alarm trigger output pin for switch control
Test	TEST, TP	2	

FUNCTION DESCRIPTION

1. Icon display: "Colon" icon is on in alarm time setting mode and flashing at 1Hz rate in normal time, alarm time and normal time setting mode
"PM" icon is on from 12:00 PM to 11:59 PM and off from 12:00 AM to 11:59AM
"☺" icon is on in alarm on mode and off in alarm off mode
"||" icon is on in alarm time indication and off in normal time indication
"☺" icon is on in snooze standby mode and flashing at 1Hz rate in snooze operation mode and it is off in alarm off mode.
2. Operation Mode: Normal Time Mode, Alarm Time Mode --- Normal Operation Mode
Alarm Time Setting Mode, Normal Time Setting Mode --- Setting Mode

In setting mode of alarm time or normal time, Hour or Minute digit can advance +1 by HR or MIN switch is depressed once; or fast advance at 4 Hz rate after HR or MIN switch is depressed for more than 2 seconds.

In normal time and alarm time mode, when HR or MIN is depressed, LCD shows the set-in alarm time and the icon “” will also show up.

- 3. Mode Selection:
 - Normal time mode HR and MIN are all off;
 - Alarm time mode HR or MIN is on;
 - Normal time setting mode NORS is on and ALS is off;
 - Alarm time setting mode NORS is off and ALS is on;
 - Alarm off mode ALOFF is on and SNZ is off;
 - Snooze standby mode ALOFF is off and SNZ is on.

- 4. Alarm Function: Alarm buzzer will sound for 60 seconds when it is time of the set-in alarm time in all the alarm on mode (when icon “” displaying on LCD). A momentary closure of ALSTOP, or changing any mode switch will stop the alarm sound. During alarm, TRIG output is high.

The 60 seconds alarm sound is a 4 steps variable alarm tone with crescendo. The detail is shown in the diagram of “Waveform of BD Pin” in the last page.

- 5. Snooze Function: This function can be operated in Alarm Time Mode. When it is time of the set-in alarm time, buzzer sound will output and the icon “” will flash at 1 Hz rate. If ALSTOP is turned on while the buzzer is sounding, alarm sound will be suspended at once and buzzer sound will output 4 minutes later. If ALSTOP is not turned on while the buzzer is sounding, alarm sound will last 60 seconds then go to the snooze standby mode (shown in the digram below)

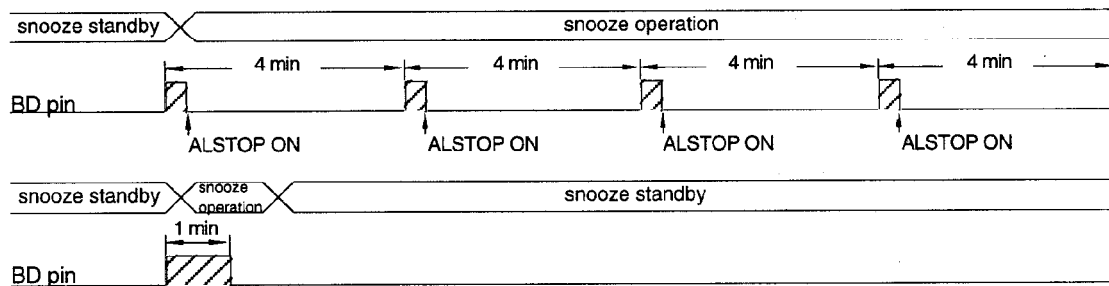

ELECTRICAL CHARACTERISTICS

(Ta = 25°C, VSS = 0V, VDD = 1.5V; unless otherwise specified)

Parameter	Symbol	Min.	Typ.	Max.	Unit	Test Condition
Operating voltage	VDD1	1.2	1.5	1.65	V	-
	VDD2	2.2	3.0		V	
Oscillator Start Voltage	Vosc	1.45	-	-	V	Within 2 sec
Supply Current	IDD	-	1.6	3.0	μA	Without Load
Trigger Output Current	ITP	0.2	0.25	-	mA	VOH = 1.2V
Switch Activation Current	ISW	0.1	1.0	3.0	μA	VIN = VDD
Alarm Drive Current	IALA	0.2	0.5	-	mA	Vsat = 0.5V (Both Direction)
Oscillator Frequency	Fosc	-	32,768	-	Hz	-
Oscillator Input Capacitor	CIN	-	20	-	pF	-
Time Stability	Tstb	-	-	1	ppm	VDD = 1.35 ~ 1.65V
Switch Debouncing Time	Tdeb	-	60	-	mSec	-
Alarm Output Frequency	FAL	-	4096x 8x1	-	Hz	-

3.5-DIGIT LCD FORMAT

PIN	1	2	3	4	5	6	7	8
COM1	COM1		COL	D2	E2	G2	C2	E3
COM2		COM2	PM	BC1	F2	A2	B2	F3

PIN	9	10	11	12	13	14	15	
COM1	G3	C3	E4	G4	C4	SNZ	D4	
COM2	AD3	B3	F4	A4	B4	ALM	AS	

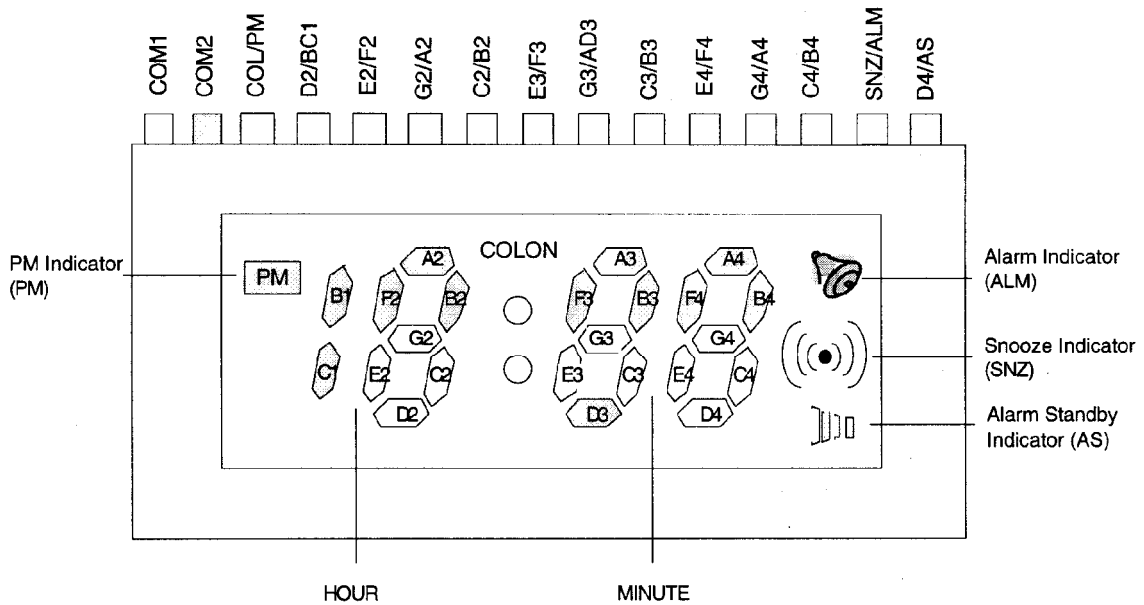

APPLICATION DIAGRAM

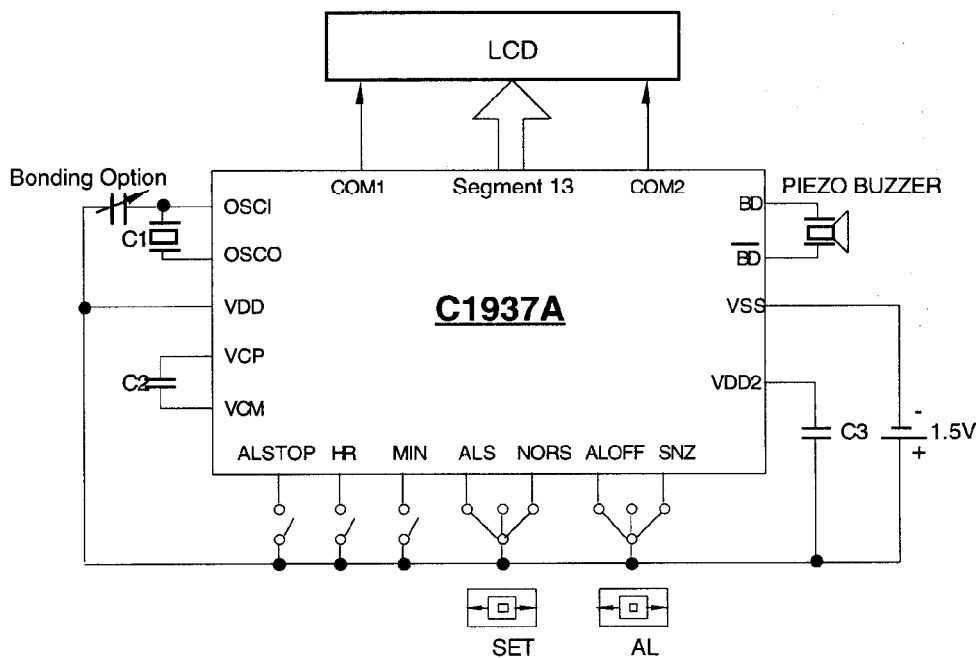

Note: 1. C1 = 5 - 35 pF C2 = C3 = 0.1 μF
 2. Substrate should be connected to VSS

PAD DIAGRAM

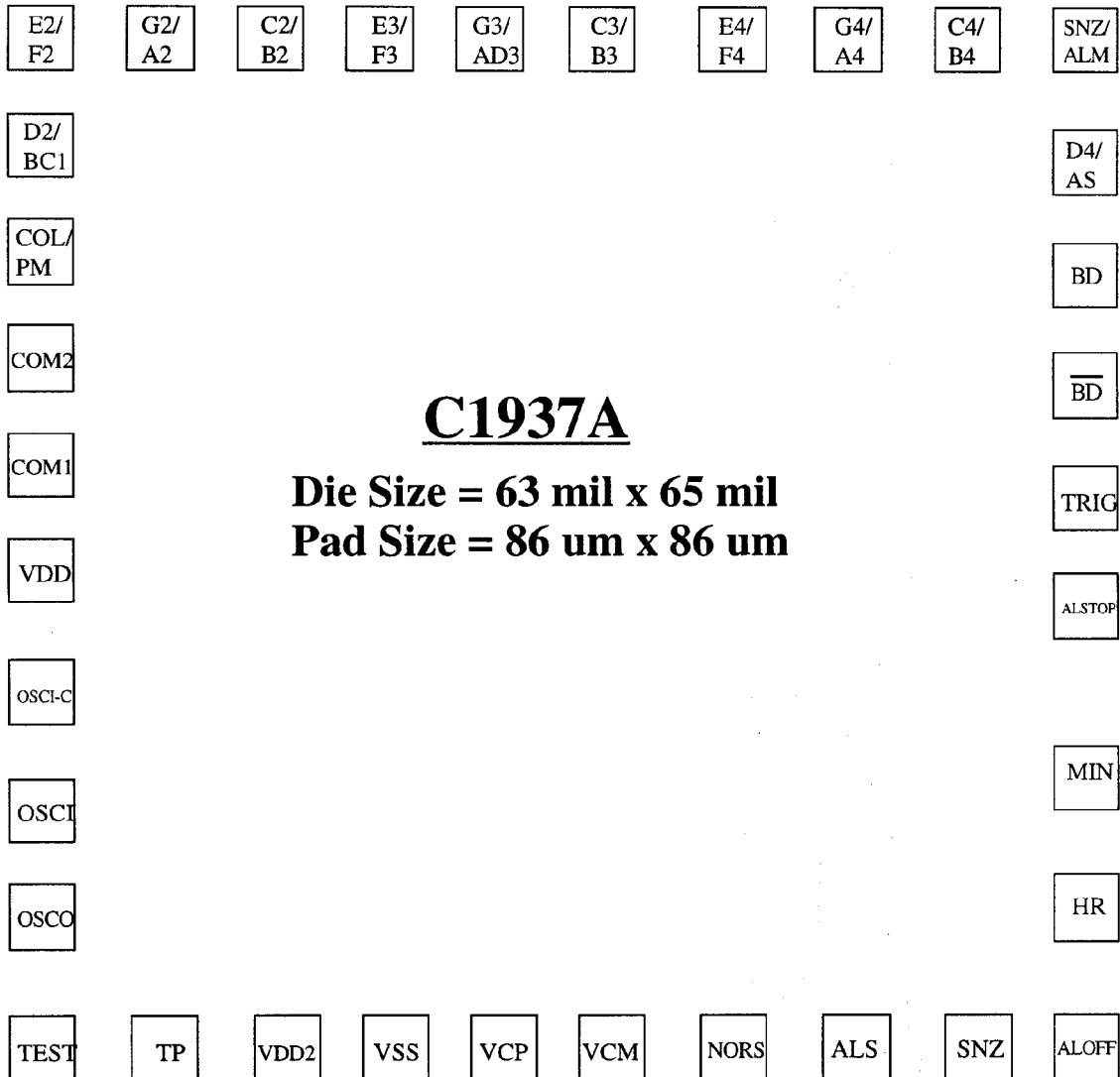

The Co-ordinate For Low Left Corner of Each Pad

TP (-564.8, -713.2)	HR (638.2, -530.3)	G4/A4 (327.9, 627.2)	COL/PM (-724.2, 341.9)
VDD2 (-405.5, -713.2)	MIN (638.2, -356.2)	E4/F4 (178.2, 627.2)	COM2 (-724.2, 200.9)
VSS (-264.5, -713.2)	ALSTOP (638.2, -130.8)	C3/B3 (5.8, 627.2)	COM1 (-724.2, 59.9)
VCP (-123.5, -713.2)	TRIG (638.2, 15.2)	G3/AD3 (-140.2, 627.2)	VDD (-724.2, -81.1)
VCM (17.5, -713.2)	$\overline{\text{BD}}$ (638.2, 166.2)	E3/F3 (-284.2, 627.2)	OSCI-C (-724.2, -240.4)
NORS (177.2, -713.2)	BD (638.2, 311.5)	C2/B2 (-427.0, 627.2)	OSCI (-724.2, -399.7)
ALS (336.9, -713.2)	D4/AS (638.2, 462.8)	G2/A2 (-568.9, 627.2)	OSCO (-724.2, -540.7)
SNZ (496.2, -713.2)	SNZ/ALM (638.2, 627.2)	E2/F2 (-724.2, 627.2)	TEST (-724.2, -713.2)
ALOFF (638.2, -713.2)	C4/B4 (484.0, 627.2)	D2/BC1 (-724.2, 483.2)	